

iHealth[®] Vesa

Smart Water Flosser

Instruction Manual

F5043

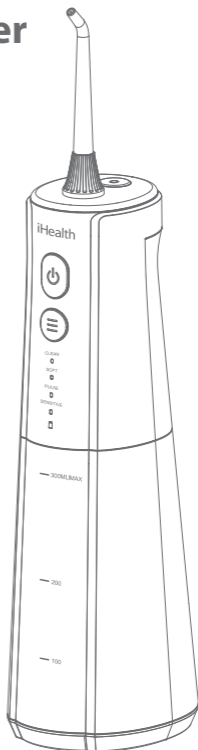

Before operating this product, please read these instructions completely and save this manual for future use.

IMPORTANT SAFEGUARDS

All information in this instruction manual is provided to promote proper, safe operation of this device to avoid injuries and equipment damage.

READ THIS INSTRUCTION MANUAL CAREFULLY BEFORE USING THE PRODUCT

WARNINGS

- This appliance can be used by individuals 8 years of age and up. Individuals with reduced physical, sensory, or mental capabilities, or lack of experience and knowledge, should have supervision or further instruction regarding the use of the appliance in a safe way and to understand the hazards involved.
- This appliance is not a toy. Children shall not play with the appliance. Cleaning and user maintenance shall not be carried out by children without supervision.
- This appliance should not be used by toddlers, infants, or individuals who are unable to operate. Please keep it out of the reach of children under eight years of age.
- Never alter the appliance. Do not disassemble or attempt repairs.
- Do not place or store the product where it can fall or be pulled into a bathtub or sink.
- If the product falls into the water, do not reach for the product. Unplug immediately.
- Do not use the product while bathing.
- The product battery is rechargeable and, therefore, cannot be replaced by the user. Do not attempt to replace the battery.
- The rechargeable battery must be removed from the appliance before it is scrapped. The appliance must be disconnected from the supply mains when removing the battery.
- The battery must be disposed of safely. For instructions on how to remove it, please see "Battery Removal."
- Use an adapter that meets local regulatory certification requirements (Output: 5V, 1A).
- Do not fill the tank with water warmer than 104 °F (40 °C).



- To avoid hazards, if this product's external flexible cable or cord is damaged, it shall be replaced by the original equipment manufacturer, service agent, or a similar qualified person. Contact customer service.
- Keep the cord away from heated surfaces.
- Please do not use this product without a tip.
- Do not submerge the device in water.
- Do not use it for any purpose other than oral cleaning.
- Keep the tip away from children. It is small enough to be swallowed and can become lodged in the throat.
- Do not use mouthwash in the water reservoir. Certain types of mouthwash may damage the equipment by causing the housing or water reservoir to crack.
- People who experience tooth or gum pain should stop using the device immediately and consult their dentist.
- Do not press the tip too firmly against your teeth or gums. Doing so may injure your gums.

BOX CONTENTS

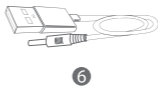
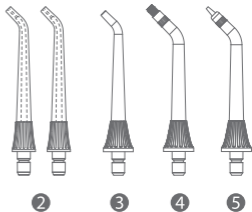
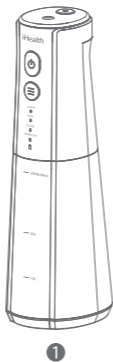
- 1 Water flosser x1
- 2 Microbubble jet tip x 2
- 3 Standard tip x 1
- 4 Orthodontic tip x 1
- 5 Pocket tip x 1
- 6 Charging cable x 1
- 7 Instruction manual x1

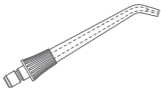

TIP INSTRUCTIONS

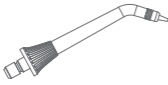
Microbubble Jet Tip	Best for
	Daily cleansing, Gingival sensitivity
Standard Tip	Best for
	Daily use
Orthodontic Tip	Best for
	Braces, Orthodontic Appliances
Pocket Tip	Best for
	Periodontal Pockets, Furcation

CONTENTS AND DISPLAY INDICATORS

- a. Tip
- b. On/Off button
- c. Mode button
- d. Mode indicator
- e. Charging indicator
- f. Water suction tube
- g. Water tank
- h. Tip-release button

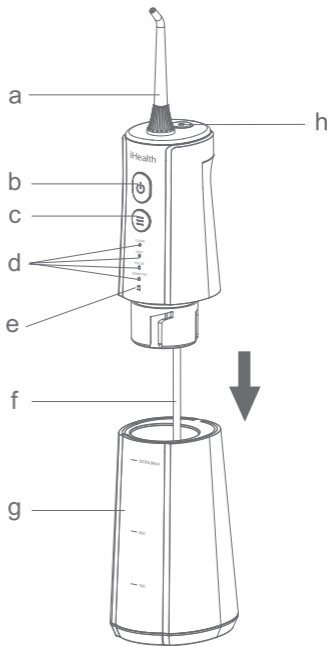

Note:

Some liquid may remain inside the appliance tank and water suction tube. The remaining distilled water was used for the performance (water flow) test.

SETUP AND OPERATION

Charging the device

1. Locate the device's charging port and insert the charging cord securely into the charging socket. Before plugging in the appliance, ensure no liquid is inside the charging port.
2. Insert the charging adaptor securely into a power outlet.
3. The charging indicator blinks when the device is charging and turns off after it is fully charged.
4. Cover the charger port when finished charging.

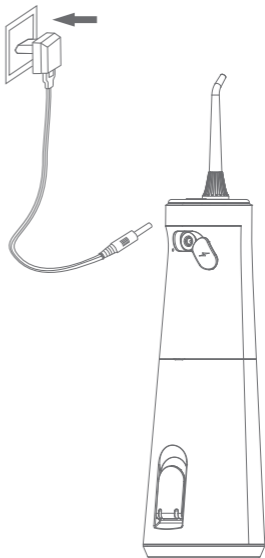

Note:

If the charging indicator blinks during or after flossing, it means the battery needs to be recharged. A complete recharging will take about 4 hours.

Using the water flosser

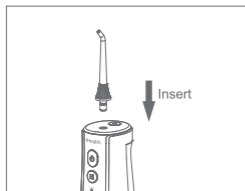

1. Installing the Tip:
Attach the tip to the unit.

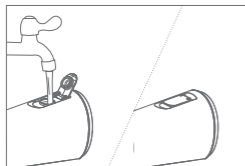

2. Water Tank Filling Methods (Either-or):
① Open the water tank cap to fill the tank.

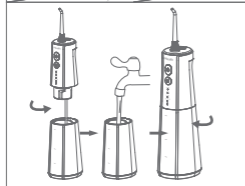

- ② Alternatively, rotate to remove the water tank, fill it with water (temperature should not exceed 104°F (40°C)), then reattach the tank to the unit.

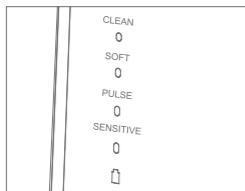

3. Mode Selection
Select the desired mode by pressing the "Mode" button.

Modes:

- * Clean: Normal cleansing.
- * Soft: Gentle cleansing.
- * Pulse: Cleansing and massaging the gums.
- * Sensitive: Softer cleaning for sensitive gums and first-time users.

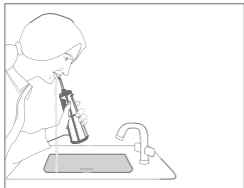

4. Before Use (Please refer to "Tip Usage")
Lean slightly forward, keep the device upright, insert the tip deep into your mouth, and aim the tip at the gaps between your teeth.

5. Starting Flossing
Press and hold the "On/Off" button for 2 seconds to start flossing.

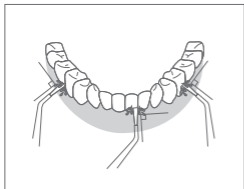

Recommended Techniques:

- Rinse along the gum line, pausing for 1-2 seconds on each tooth.
- Ensure the water stream is perpendicular to the area being rinsed, while keeping your mouth slightly open to allow the water to flow out.

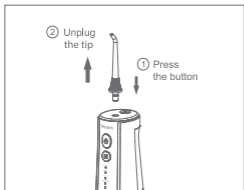

6. After Flossing
Press the "On/Off" button again to turn off the device.

Note:

Before replacing the tip, turn off the device and press the tip release button to remove and replace the tip.

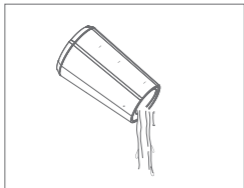

7. Detach the water tank and drain the water.

TIP USAGE

Microbubble Jet Tip

The microbubble tip is designed to be gentle, making it easier for first-time users and those with sensitive teeth.

How to Use:

1. Hold the tip at a 90-degree angle to your teeth.
2. Gently place it where your teeth and gums meet.
3. Slide the brush along the gum line.
4. Clean each tooth for 2-3 seconds before moving to the next one.

Replace: Every 6 months

Standard Tip

The standard tip is designed for day-to-day use with a stronger water flow.

How to Use:

1. Hold the tip at a 90-degree angle to your teeth.
2. Gently place it where your teeth and gums meet.
3. Slide the brush along the gum line.
4. Clean each tooth for 2-3 seconds before moving to the next one.

Replace: Every 6 months

Orthodontic Tip

The orthodontic tip is designed with a tapered-brush end to clean plaque from braces and teeth.

How to Use:

1. Gently slide the tip along the gum line.
2. Pause briefly and lightly brush between the teeth and around the braces.
3. Move the tip to the next tooth and repeat.

Replace: Every 3 months

Pocket Tip

The pocket tip is designed to deliver water or antibacterial solution deep into periodontal pockets, as dental professionals recommend.

How to Use:

1. Set your device to the lowest pressure setting.
2. Position the flexible tip at a 45-degree angle towards a tooth.
3. Gently move the tip until it reaches below the gum line.
4. Direct the tip into the periodontal pocket.
5. Ensure gentle movements to avoid discomfort or damage.

Replace: Every 3 months

CLEANING AND MAINTENANCE

Cleaning the Unit

1. Detach the water tank and drain the water.
2. Press the "On/Off" button to turn on the unit and drain the water from the appliance.
3. Press the "On/Off" button again to turn off the unit and close the water tank cap.
4. Wipe down the device with a dry cloth.

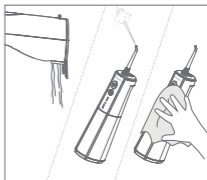

Note:

To prevent bacteria from propagating, ensure no water remains inside the unit. If the appliance will not be used for a long time, wipe and dry it as soon as possible before storing it.

Maintenance

Use only water or a mild, non-abrasive cleanser to clean the device. Never use acidic or abrasive agents (e.g., vinegar or lime scale removers) since they may damage the device. Do not wash using hot water over 104°F (40 °C). Keep the device away from high-temperature areas and avoid direct sunlight.

Main unit

1. Remove dirt from the product by wiping it down with a damp cloth and liquid soap and then wiping it dry.
2. Do not submerge the main unit in water to clean it.
3. Dry thoroughly after cleaning.

Tip

1. Wash with water and wipe with a soft cloth.
2. Replace the tip according to the instruction in "TIP USAGE".

Water suction tube

1. Wash with water and wipe with soft cloth.
2. Do not bend, pull, or twist the water suction tube.

Water tank

1. Wash with water and wipe with soft cloth.
2. Dry the tank when not using for a long period.

TROUBLESHOOTING

Problem	Possible Cause	Solution
It does not work.	The product is newly purchased or has been left unused for more than 3 months.	Charge the unit for at least 4 hours.
It only works for a few minutes, even after charging.	The battery has reached the end of its life cycle.	Contact customer service.
	Charging time was insufficient.	Charge the unit for at least 4 hours.
Water pressure is very low.	There is dirt stuck in the tip.	Replace the tip.
	The tip is deformed.	
Water does not come out.	The tank is empty.	Fill up the tank.
	The appliance is tilted too much while in use.	Use with the appliance in a vertical state.
	The product is newly purchased or has been left unused for a long period.	Pull out the tip, then flush the tip hole with water.

BATTERY REMOVAL

The rechargeable battery inside your appliance is easy to remove for recycling (Fig.1). At the end of the product's life cycle and before disposal, please remove the battery from the device by following the instructions below, making sure to protect your eyes, hands, and fingers and the surface upon which you are working.

1. Remove the tip from the device.
2. Rotate the water tank to detach it from the device (fig.2)
3. Flip the device over and remove the two rubber covers beside the suction tube.(fig.3)
- 3.Unscrew the two screws located beneath the rubber covers.(fig.3)
4. Flip the device back over and use a screwdriver to pry off the top cover. (fig.4)
5. Remove the white plastic piece covering the battery compartment
6. Unscrew the two screws beside it.(fig.4)
7. Push the battery compartment so it slides out from the other end.
8. Cut the battery cord and pull out the battery.(fig.5)

If you have recycling questions, please contact your local waste management office.

WARNING:

Please make sure the unit is unplugged before cutting. The battery of this product is not replaceable. Please only disassemble the product if you are disposing of it. Otherwise, the warranty service will be void.

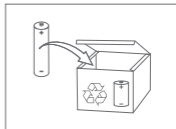

Fig. 1

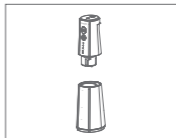

Fig. 2

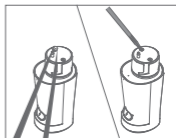

Fig. 3



Fig. 4

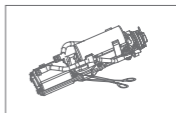

Fig. 5

WARRANTY

iHealth Labs, Inc. ("iHealth") warrants the iHealth hardware (the "Product"), and only the Product, against defects in materials and artistry under regular use for one year (US) or two years (U) from the date of purchase by the original purchaser ("Warranty Period"). Under this Limited Warranty, if a defect arises and a valid claim is received by iHealth within the Warranty Period regarding the Product, at its option and to the extent permitted by law, iHealth will either (1) repair the Product using new or refurbished replacement parts or (2) exchange the Product with a new or refurbished Product. In the event of a defect, to the extent permitted by law, these are the sole and exclusive remedies.

This warranty does not apply: (a) to consumable parts, such as the flosser tip, that diminish over time unless failure has occurred due to a defect in materials or quality; (b) to cosmetic damage, including but not limited to scratches, dents; (c) to damage caused by accident, abuse, misuse, contact with liquid; (d) to damage caused by operating the iHealth product outside the instruction manual, the technical specifications or other iHealth product published guidelines; (e) to damage caused by service performed by anyone who is not a representative of iHealth or one of its representatives.

"iHealth" is a trademark of iHealth Labs, Inc.

iHealth

USA:

Manufactured for iHealth Labs, Inc.

880 W Maude Ave, Sunnyvale, CA 94085 USA

www.ihealthlabs.com +1-855-816-7705



Shenzhen Risun Technology Co., Ltd.

Building A, No.6 of Xinmu Road, Xinmu Community, Pinghu,
shenzhen 518111, China



Made in China